

Analog Devices Welcomes Hittite Microwave Corporation

NO CONTENT ON THE ATTACHED DOCUMENT HAS CHANGED



THIS PAGE INTENTIONALLY LEFT BLANK



Typical Applications

The HMC497LP4(E) is ideal for:

- UMTS, GSM or CDMA Basestations
- Fixed Wireless or WLL
- ISM Transceivers, 900 & 2400 MHz
- GMSK, QPSK, QAM, SSB Modulators

Features

- Very Low Noise Floor: -161 dBm/Hz
- Very High Linearity: +22 dBm OIP3
- High Output Power: +9 dBm Output P1dB
- High Modulation Accuracy
- DC - 700 MHz Baseband Input

Functional Diagram

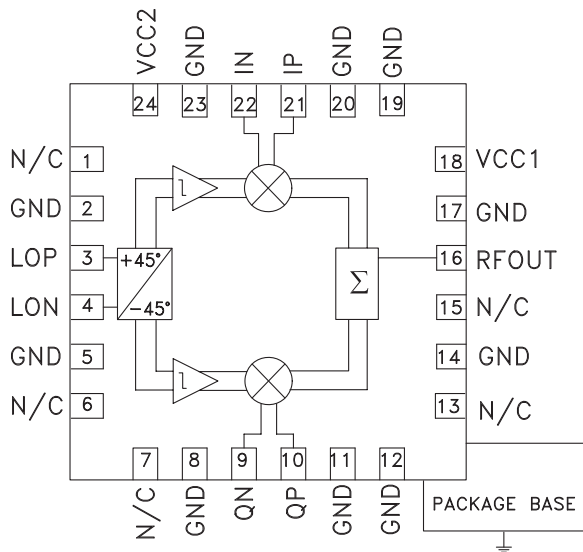

General Description

The HMC497LP4(E) is a low noise high linearity Direct Quadrature Modulator RFIC which is ideal for digital modulation applications from 100 - 4000 MHz including; Cellular/3G, Broadband Wireless Access & ISM circuits. Housed in a compact 4x4 mm (LP4) SMT QFN package, the RFIC requires minimal external components & provides a low cost alternative to more complicated double upconversion architectures. The RF output port is single-ended and matched to 50 Ohms with no external components. The LO requires -6 to +6 dBm and can be driven in either differential or single-ended mode while the baseband inputs will support modulation inputs from DC - 700 MHz typical. This device is optimized for a supply voltage of +4.5V to +5.5V and consumes 170 mA @ +5V supply.

Electrical Specifications, See Test Conditions on following page herein.

| Parameter | Min. | Typ. | Max. | Min. | Typ. | Max. | Min. | Typ. | Max. | Min. | Typ. | Max. | Units |
|-------------------------------------|-----------|------|------|-------------|------|------|-------------|------|------|-------------|------|------|--------|
| Frequency Range, RF | 450 - 960 | | | 1700 - 2200 | | | 2200 - 2700 | | | 3400 - 4000 | | | MHz |
| Output P1dB | | +8 | | | +8 | | | +7 | | | +6 | | dBm |
| Output Noise Floor | | -161 | | | -159 | | | -157 | | | -150 | | dBm/Hz |
| Output IP3 | | +22 | | | +22 | | | +20 | | | +17 | | dBm |
| Output Power | +4 | +6 | | +3 | +5 | | +2 | +5 | | 0 | +3 | | dBm |
| Carrier Feedthrough (uncalibrated) | | -38 | | | -36 | | | -32 | | | -30 | | dBm |
| Sideband Suppression (uncalibrated) | | 43 | | | 42 | | | 33 | | | 22 | | dBc |
| LO Port Return Loss | | 25 | | | 15 | | | 14 | | | 13 | | dB |
| RF Port Return Loss | | 11 | | | 20 | | | 17 | | | 11 | | dB |



Electrical Specifications, (continued)

| Parameter | Conditions | Min. | Typ. | Max. | Units |
|--|-------------------------------------|------|------|------|-------|
| RF Output | | | | | |
| RF Frequency Range | | 100 | | 4000 | MHz |
| RF Return Loss | | | 15 | | dB |
| LO Input | | | | | |
| LO Frequency Range | | 100 | | 4000 | MHz |
| LO Input Power | | -6 | 0 | +6 | dBm |
| LO Port Return Loss | | | 15 | | dB |
| Baseband Input Port | | | | | |
| Baseband Port Bandwidth | 3 dB Bandwidth with 50Ω source. | DC | | 700 | MHz |
| Baseband Input DC Voltage (Vbbdc) | | +1.4 | +1.5 | +1.6 | V |
| Baseband Input DC Bias Current (Ibbdc) | Single-ended. | | 90 | | μA |
| Single-ended Baseband Input Capacitance | De-embed to the lead of the device. | | 4.5 | | pF |
| DC Power Requirements See Test Conditions Below | | | | | |
| Supply Voltage (Vcc1, Vcc2) | | +4.5 | +5.0 | +5.5 | V |
| Supply Current (Icc1, Icc2) | | | 168 | | mA |

Test Conditions: Unless Otherwise Specified, the Following Test Conditions Were Used

| Parameter | Condition |
|---|---|
| Temperature | +25 °C |
| Baseband Input Frequency | 200 kHz |
| Baseband Input DC Voltage (Vbbdc) | +1.5V |
| Baseband Input AC Voltage (Peak to Peak Differential, I and Q) | 1.6V |
| Baseband Input AC Voltage for OIP3 Measurement (Peak to Peak Differential, I and Q) | 800 mV per tone @ 150 & 250 kHz |
| Frequency Offset for Output Noise Measurements | 20 MHz |
| Supply (Vcc1, Vcc2) | +5.0V |
| LO Input Power | 0 dBm |
| LO Input Mode | Single-Ended through LON |
| Mounting Configuration | Refer to HMC497LP4 Application Schematic Herein |
| Sideband & Carrier Feedthrough | Uncalibrated |

Calibrated vs. Uncalibrated Test Results

During the Uncalibrated Sideband and Carrier Suppression tests, care is taken to ensure that the I/Q signal paths from the Vector Signal Generator (VSG) to the Device Under Test (DUT) are equal. The “Uncalibrated, +25 °C” Sideband and Carrier Suppression plots were measured at room temperature, while the “Uncalibrated, over Temperature” Sideband and Carrier Suppression plots represent the worst case uncalibrated suppression levels measured at T= -40 °C, +25 °C, and +85 °C.

The “Calibrated, + 25 °C” Sideband Suppression data was plotted after a manual adjustment of the I/Q amplitude balance and I/Q phase offset (skew) at +25 °C, and at each LO input power level. The +25 °C adjustment settings were held constant during tests over temperature. The “Calibrated, over Temperature” plots represent the worst case calibrated Sideband Suppression levels at T= -40 °C, +25 °C, and +85 °C.

The “Calibrated, +25 °C” Carrier Suppression data was plotted after a manual adjustment of the Ip/In & Qp/Qn DC offsets at +25 °C, and at each LO input power level. The +25 °C adjustment settings were held constant during tests over temperature. The “Calibrated, over Temperature” plots represent the worst case Carrier Suppression levels measured at T= -40 °C, +25 °C, and +85 °C.

Wideband Performance vs. Frequency

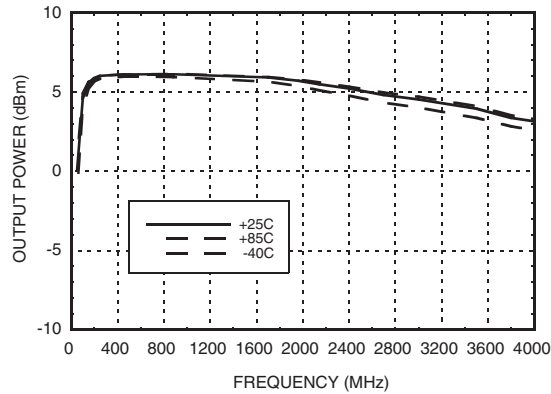

Output IP3, P1dB & Noise Floor @ 20 MHz Offset vs. Frequency

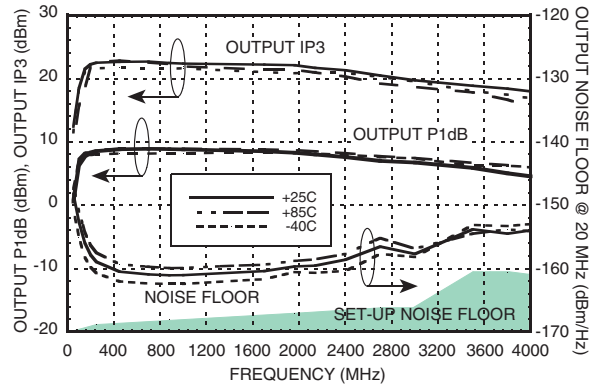

Uncalibrated Carrier Feedthrough [1] vs. Frequency

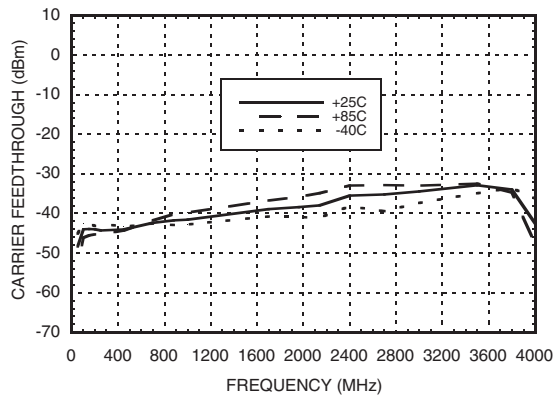

Calibrated Carrier Feedthrough [1] vs. Frequency

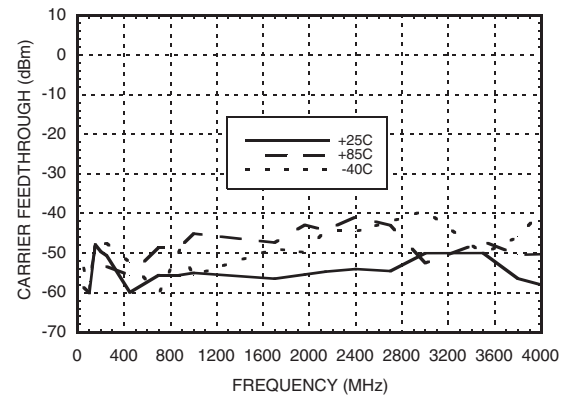

Sideband Suppression vs. Frequency

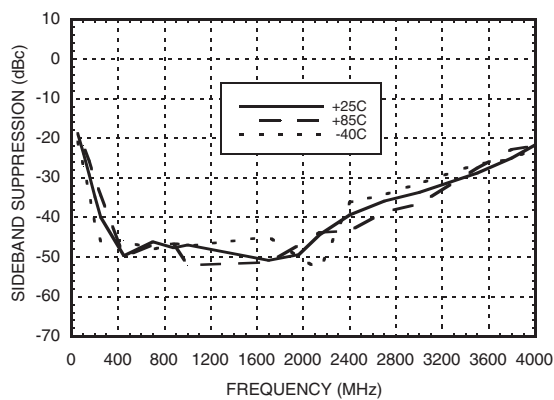

Return Loss vs. Frequency

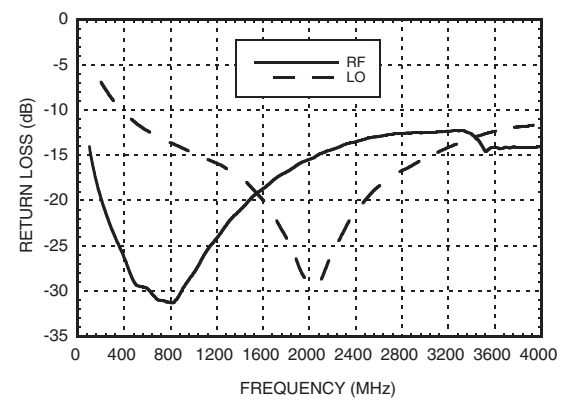

[1] See note titled "Calibrated vs. Uncalibrated test results" herein.

SiGe WIDEBAND DIRECT MODULATOR RFIC, 100 - 4000 MHz

Wideband Performance vs. Frequency Over LO Power [3]

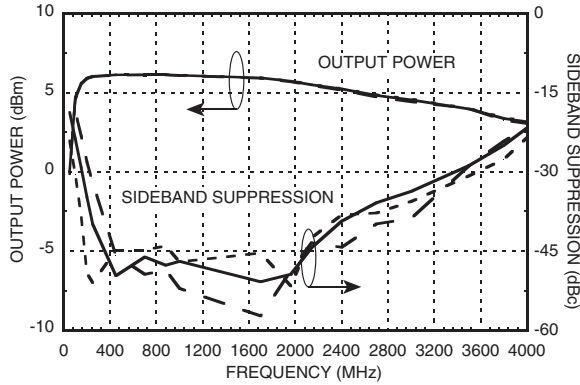

Output IP3, P1dB & Noise Floor @ 20 MHz Offset vs. Frequency Over LO Power [3]

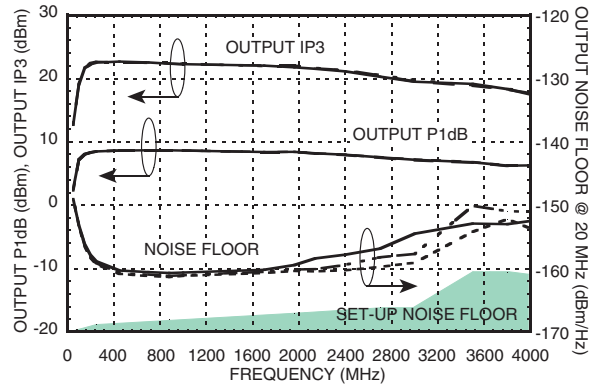

Uncalibrated Carrier Feedthrough vs. Frequency [2]

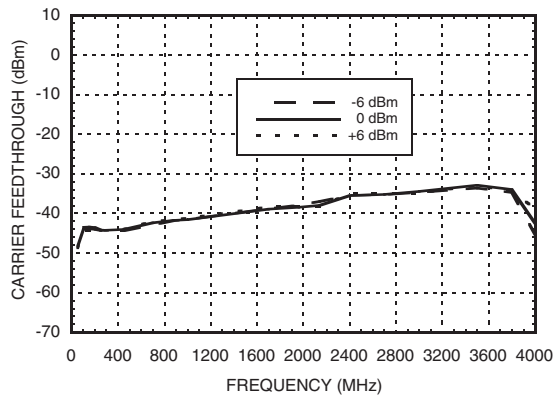

Calibrated Carrier Feedthrough vs. Frequency [2]

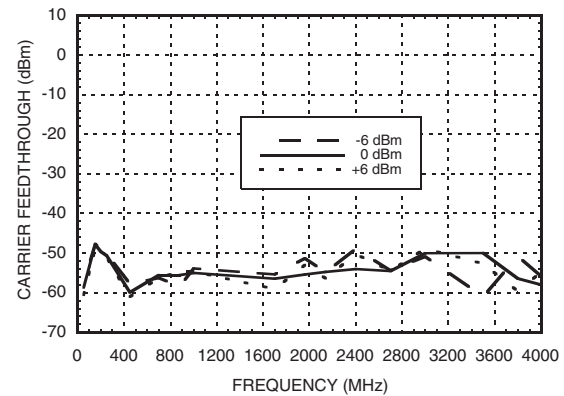

Wideband Performance vs. Frequency Over Supply Voltage [1]

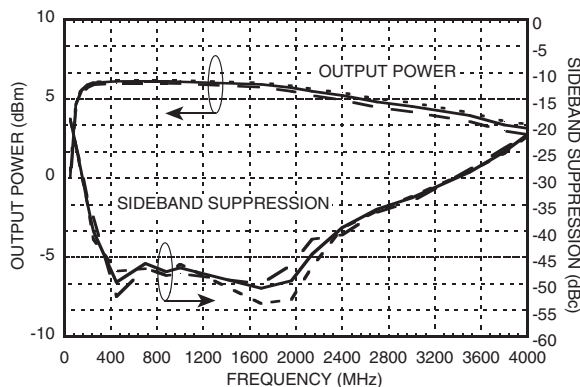

Output IP3, P1dB & Noise Floor @ 20 MHz vs. Offset Frequency Over Supply Voltage [1]

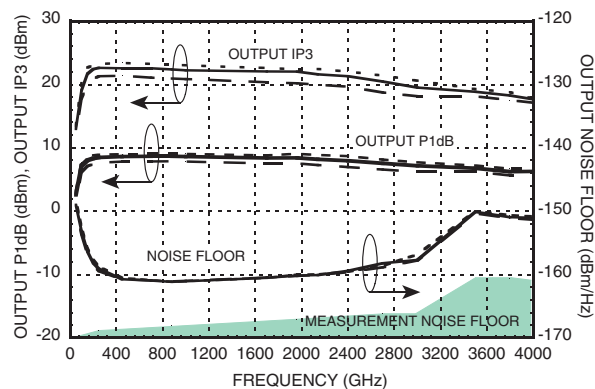

[1] See note titled "Calibrated vs. Uncalibrated test results" herein.

[2] Supply voltage from +4.5 to +5.5V.

[3] LO Power from -6 dBm to +6 dBm



SiGe WIDEBAND DIRECT MODULATOR RFIC, 100 - 4000 MHz

ACPR & Output Noise for W-CDMA @ 2140 MHz

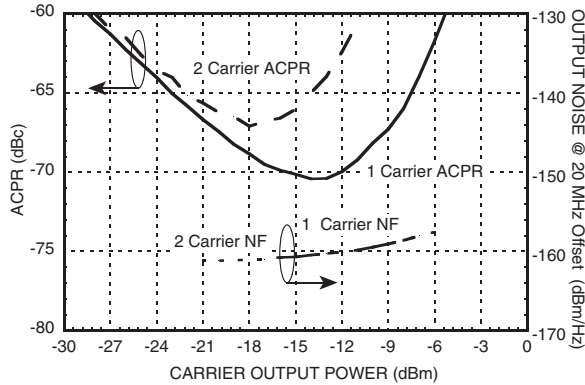

Output Noise @ 20 MHz Offset vs. LO Power Over Temperature

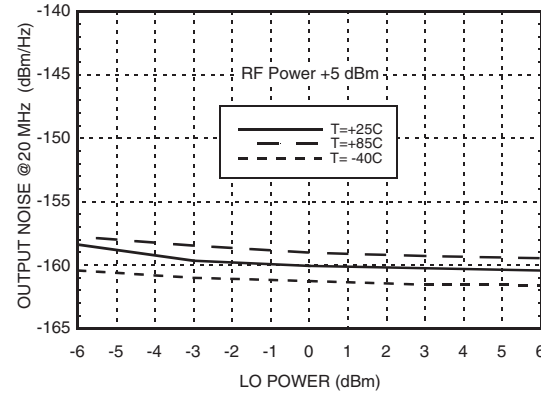

Compression Characteristic @ 2140 MHz

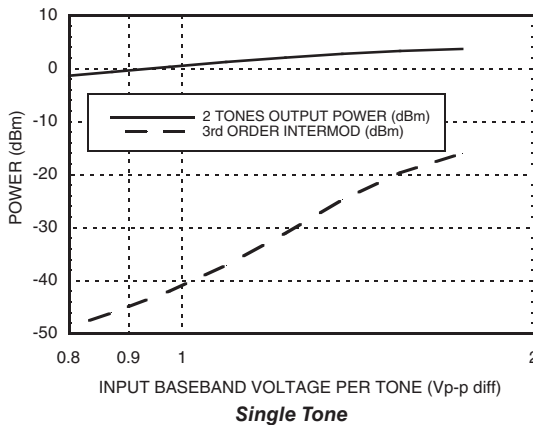

Power & Linearity @ 2140 MHz vs. Baseband Voltage

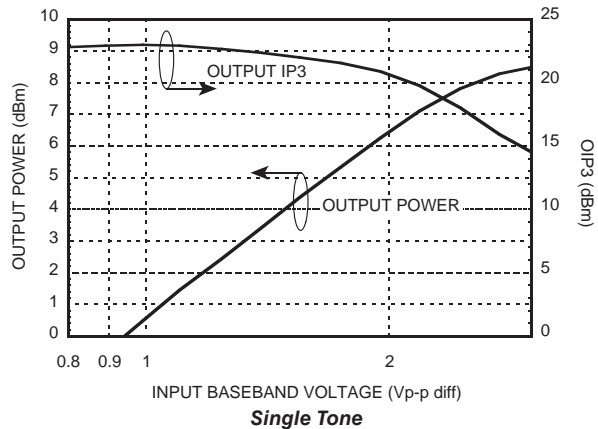

EVM vs. LO Harmonic Level & Sideband Rejection for EDGE @ 900 MHz

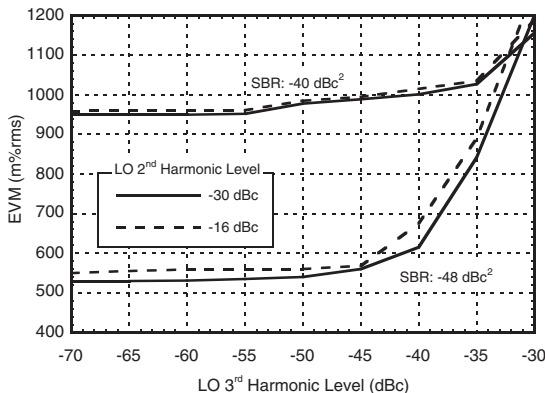

EVM vs. LO Harmonic Level & Sideband Rejection for EDGE @ 1900 MHz

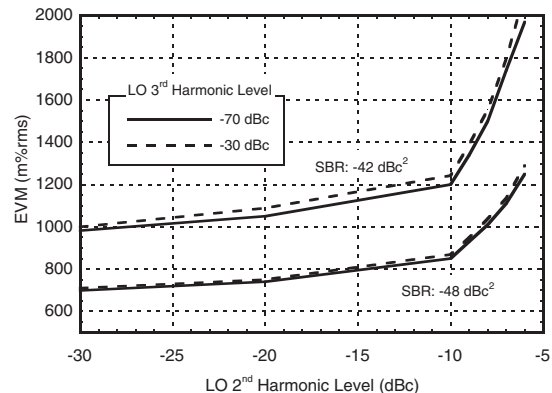

Note 1: W-CDMA (Modulation Set-up for ACPR Mode); The Baseband I and Q input signals were generated using "Test Model 1 with 64 channels" settings in the Agilent E3844C.

Note 2: The I/Q baseband amplitude and phase inputs were offset to achieve Sideband Rejection (SBR) levels. LO = +6 dBm, SSB Power = 0 dBm

For price, delivery, and to place orders, please contact Hittite Microwave Corporation:
20 Alpha Road, Chelmsford, MA 01824 Phone: 978-250-3343 Fax: 978-250-3373
Order On-line at www.hittite.com

Absolute Maximum Ratings

| | |
|--|----------------|
| Vcc1, Vcc2 | 0V to +6V |
| LO Input Power | +18 dBm |
| Baseband Input Voltage (AC + DC) (Reference to GND) | 0.0V to +2.8V |
| Channel Temperature | 150 °C |
| Continuous Pdiss (T = 85°C) (Derate 30 mW/°C above 85°C) | 1.8 Watts |
| Thermal Resistance (R _{th}) (junction to lead) | 34 °C/W |
| Storage Temperature | -65 to +150 °C |
| Operating Temperature | -40 to +85 °C |
| ESD Sensitivity (HBM) | Class 1A |



ELECTROSTATIC SENSITIVE DEVICE
OBSERVE HANDLING PRECAUTIONS

10

Outline Drawing

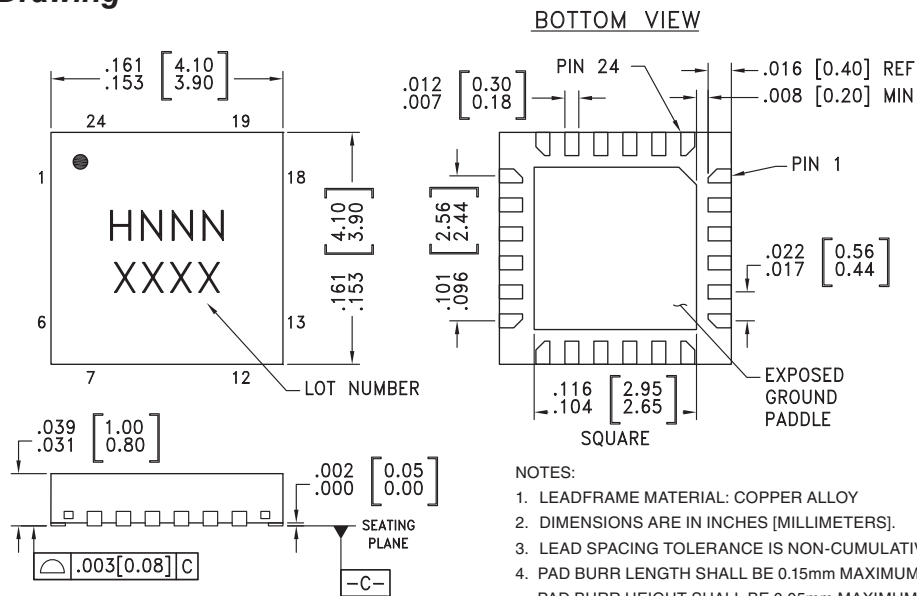

NOTES:

- LEADFRAME MATERIAL: COPPER ALLOY
- DIMENSIONS ARE IN INCHES [MILLIMETERS].
- LEAD SPACING TOLERANCE IS NON-CUMULATIVE
- PAD BURR LENGTH SHALL BE 0.15mm MAXIMUM.
PAD BURR HEIGHT SHALL BE 0.05mm MAXIMUM.
- PACKAGE WARP SHALL NOT EXCEED 0.05mm.
- ALL GROUND LEADS AND GROUND PADDLE MUST BE SOLDERED TO PCB RF GROUND.
- REFER TO HITTITE APPLICATION NOTE FOR SUGGESTED PCB LAND PATTERN.

Package Information

| Part Number | Package Body Material | Lead Finish | MSL Rating | Package Marking ^[3] |
|-------------|--|---------------|---------------------|--------------------------------|
| HMC497LP4 | Low Stress Injection Molded Plastic | Sn/Pb Solder | MSL1 ^[1] | H497 XXXX |
| HMC497LP4E | RoHS-compliant Low Stress Injection Molded Plastic | 100% matte Sn | MSL1 ^[2] | H497 XXXX |

[1] Max peak reflow temperature of 235 °C

[2] Max peak reflow temperature of 260 °C

[3] 4-Digit lot number XXXX

Pin Descriptions

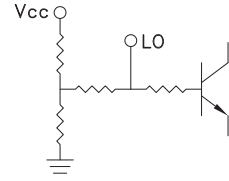
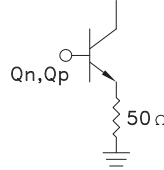
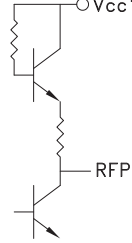
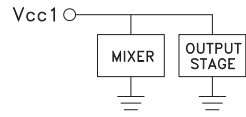
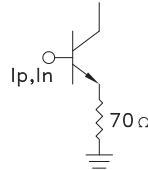
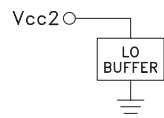
| Pin Number | Function | Description | Interface Schematic |
|-------------------------------------|----------|---|---|
| 1, 6, 7, 13, 15 | N/C | Not connected. | |
| 2, 5, 8, 11, 12, 14, 17, 19, 20, 23 | GND | These pins and the ground paddle should be connected to a high quality RF/DC ground. |  |
| 3, 4 | LOP, LON | LO inputs. Need DC decoupling capacitors. The ports could be driven single ended or differentially. |  |
| 9, 10 | QN, QP | Q channel differential baseband input. These high impedance ports should be biased around 1.5V DC. Nominal recommended baseband input is around 1.6V pp differential. |  |
| 16 | RFOUT | RF output. 50 Ohms. Needs DC blocking capacitor. |  |
| 18 | Vcc1 | Supply voltage for the mixer and output stages 79mA @ +5.0V. |  |
| 21, 22 | IP, IN | I channel differential baseband input. These high impedance ports should be at the same bias voltage (VbbDC) as Qn & Qp. |  |
| 24 | Vcc2 | Supply voltage for the LO stage 88mA @ +5V. |  |

Evaluation PCB

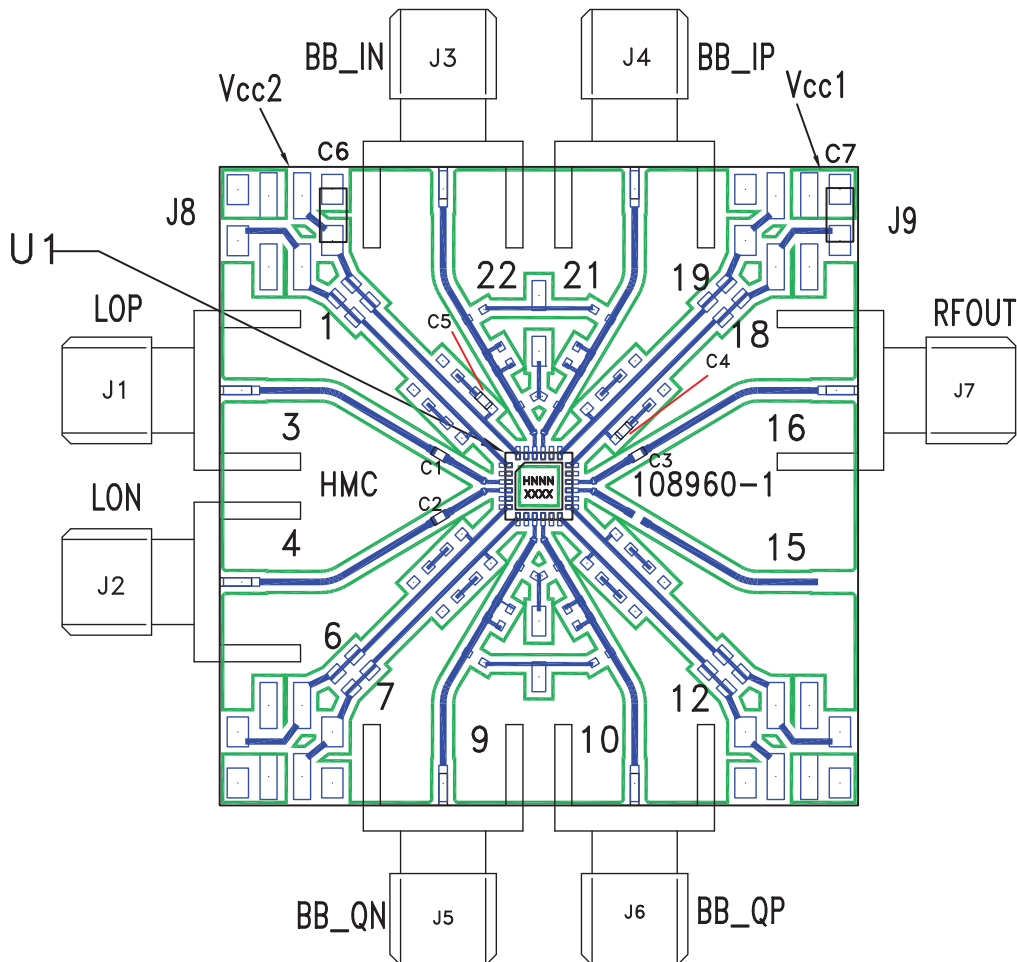

List of Materials for Evaluation PCB 108962 [1]

| Item | Description |
|---------|-----------------------------------|
| J1 - J7 | PC Mount SMA Connector |
| J8, J9 | DC Molex Connector |
| C1 - C3 | 100 pF Chip Capacitor, 0402 Pkg. |
| C4, C5 | 1000 pF Chip Capacitor, 0402 Pkg. |
| C6, C7 | 4.7 uF, Case A, Tantalum |
| U1 | HMC497LP4 Modulator |
| PCB [2] | 108960 Eval Board |

[1] Reference this number when ordering complete evaluation PCB

[2] Circuit Board Material: Rogers 4350

The circuit board used in the final application should use RF circuit design techniques. Signal lines should have 50 ohm impedance while the package ground leads and exposed paddle should be connected directly to the ground plane similar to that shown. A sufficient number of via holes should be used to connect the top and bottom ground planes. The evaluation circuit board shown is available from Hittite upon request.

Application & Evaluation PCB Schematic

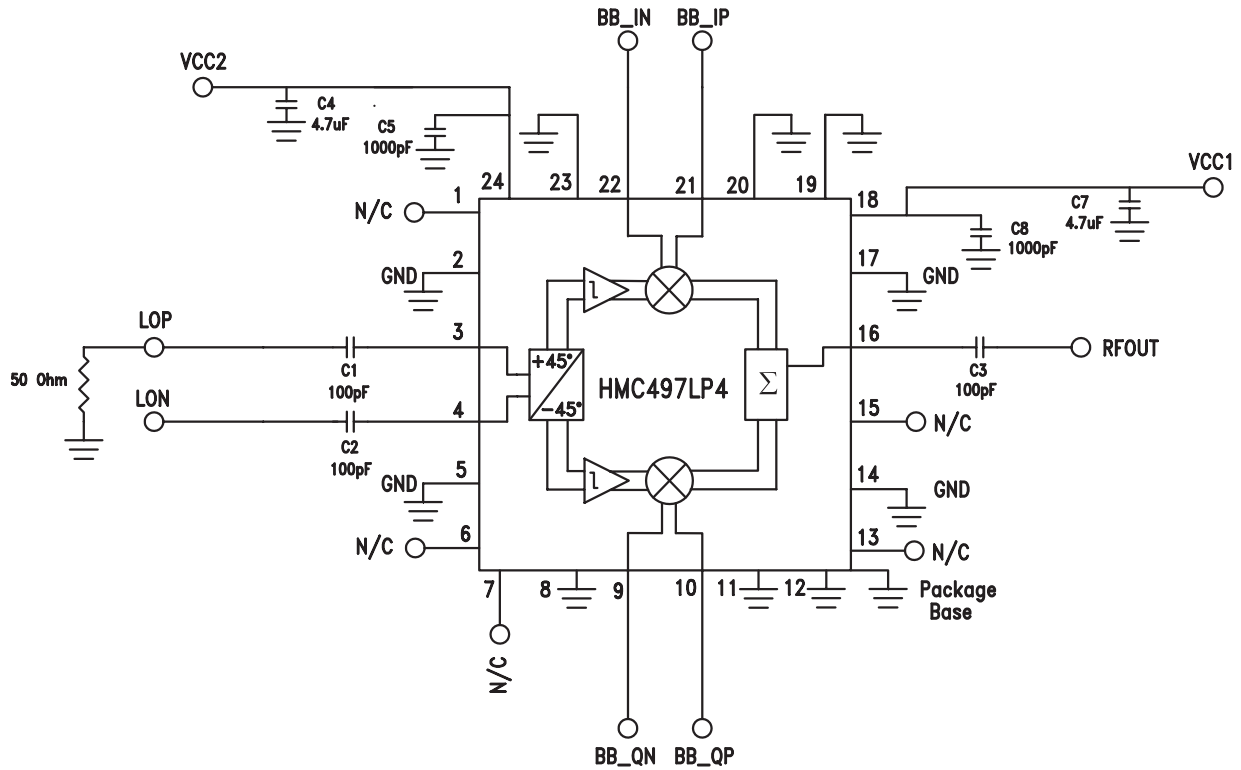

Characterization Set-up

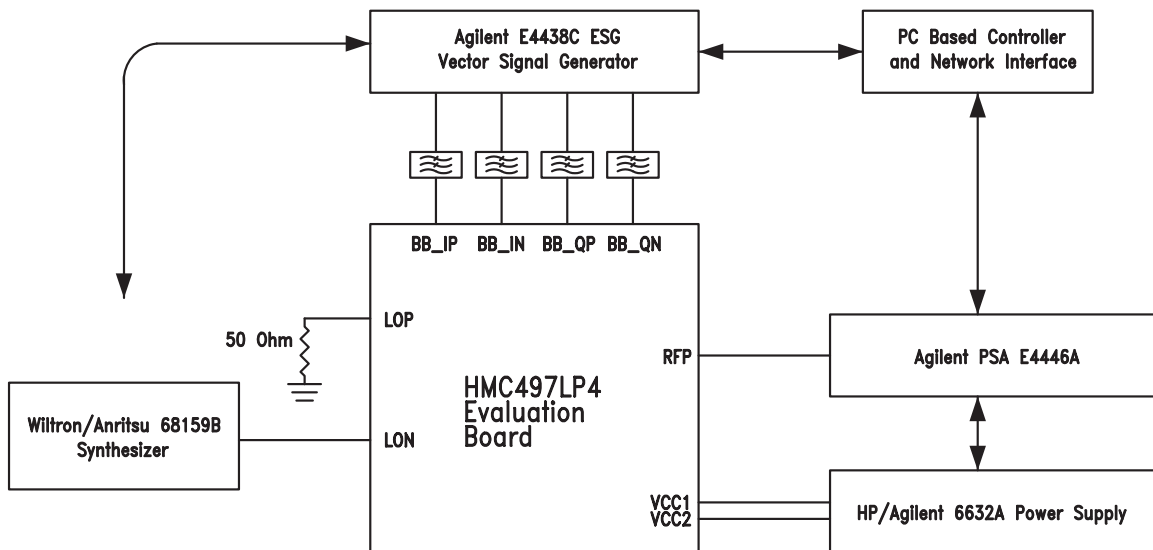



Notes: